

SUITABLE FOR MODEL



IMAGE MAY VARY FROM ACTUAL PRODUCT

SAFETY INSTRUCTION

READ CAREFULLY BEFORE INSTALLING FIXTURE. PLEASE KEEP THIS MANUAL FOR FUTURE USING. Fixtures must be wired in accordance with the National Electrical Code and all applicable local codes. Proper grounding is required for safety.

THIS PRODUCT MUST BE INSTALLED IN ACCORDANCE WITH THE APPLICATION CODE BY A PERSON FAMILIAR WITH THE CONSTRUCTION AND OPERATION OF THE PRODUCT AND THE HAZARDS INVOLVED. MAKE CERTAIN POWER OFF BEFORE INSTALLING OR MAINTAINING FIXTURE. CHECK THAT VOLTAGE IS COMPATIBLE WITH FIXTURE DRIVER, USE APPROVED CONNECTORS FOR ALL ELECTRICAL CONNECTIONS.

MAINTENANCE CAUTION

1. Review the diagrams before beginning, and make sure fixture is grounded properly.
2. For lighting controls, using functioning correctly.
3. Turn power off and wait for fixture cooling to operate.
4. Maintenance must be done by professionals.

WIRE CONNECTION

Universal voltage driver permits operation at 120V thru 277V, 50 or 60Hz

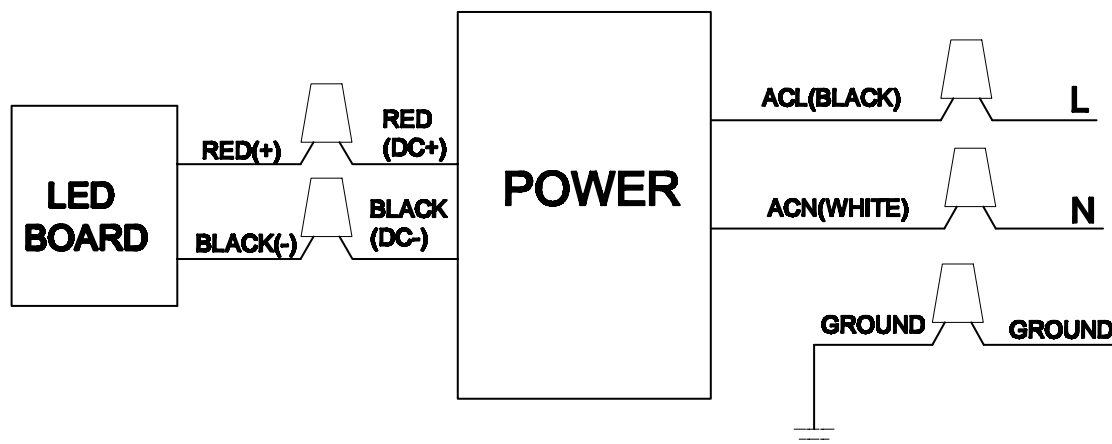

INSTALLATION

ACCESSORIES PARTS

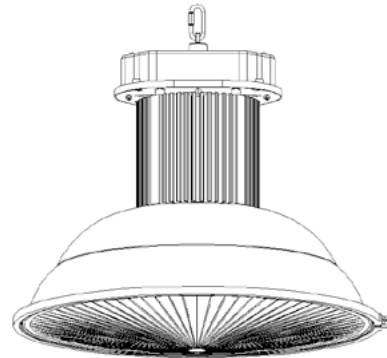
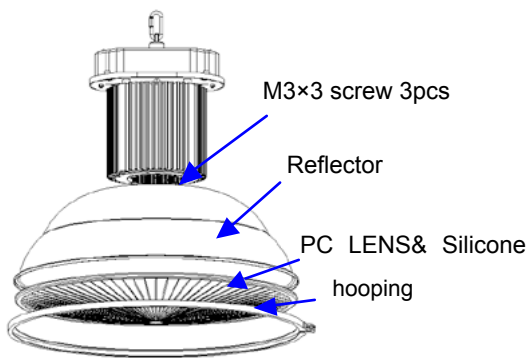

1.1 Open the cartons of reflector and PC LENS (10 pcs reflector packed in one carton, 10 pcs PC LENS with silicone pad to fix hooping packed in one carton), take them out as below picture showed.

10 pcs reflector cover

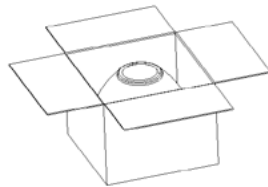

10 pcs PC LEDS

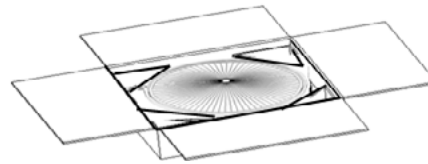

1.2 Open the carton of radiator, take out the PE bag (1 hanging ring inside) as picture1, remove the foam, then take out the radiator as picture 2. Set the radiator as below picture 3 showed, and remove the protective foam as picture 4. (Note: Never touch the LEDs by hand or something else).

PE bag with 1 hanging ring

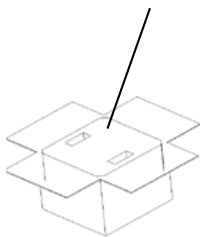

Picture 1

Remove the protective foam

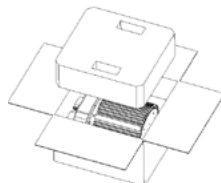

Picture 2

Never touch LEDs

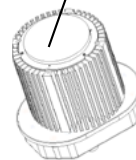

Picture 3

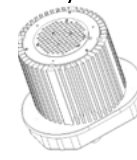

Picture 4

1.3 Screw off the 3 screws on the radiator as picture 1 showed, put one reflector cover on the radiator, then screw it onto the radiator as picture 2.

3 screws off, remember the screw holes

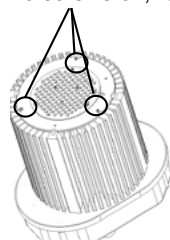

Picture 1



Picture 2

1.4 Take a PC LENS (Note: Keep PC LENS clean and avoid scratches) unscrew the butterfly screw cap of hooping as Picture 1, take installed PC LENS with silicone pad off and put to reflector as Picture 2, put clip to reflector and lock by the butterfly screw cap as picture 3.

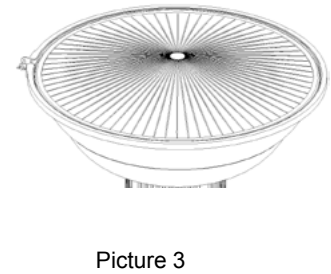
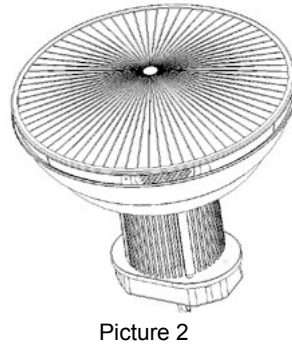
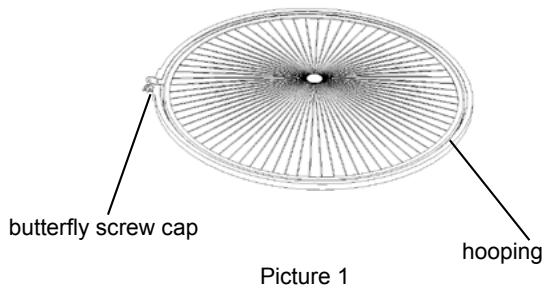

1.5 Upend the high bay, fix the hanging ring

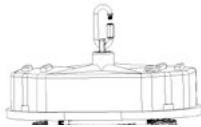

2 Installation and application

Installation type: suspending

Connect the highbay light to power cord, black wire to L, white wire to N, green wire to ground  .
Suspend the highbay light, turn on to work.



WARRANTY

LIMITED FIVE-YEAR WARRANTY. Should this product fail to perform satisfactorily due to a defect or poor workmanship within five years from the date of purchase, return it to the place of purchase and it will be replaced, free of charge. Incidental or consequential damages are excluded from the warranty.