

SUITABLE FOR MODEL



IMAGE MAY VARY FROM ACTUAL PRODUCT

SAFETY INSTRUCTION 

READ CAREFULLY BEFORE INSTALLING LAMP. PLEASE KEEP THIS MANUAL FOR FUTURE USING.
Do not connect the product to the power supply while it is in the packing unless the packing has been adapted for display purpose.
Disconnect fluorescent fixture from main power supply prior to installation to ensure the fixture is properly grounded.

1. PRODUCTS SHOULD BE INSTALLED IN ACCORDANCE WITH THESE INSTRUCTIONS, CURRENT ELECTRICAL CODES AND/OR THE CURRENT NATIONAL ELECTRIC CODE (NEC).
2. RISK OF FIRE OR ELECTRIC SHOCK. RETROFIT KIT (ALSO KNOWN AS REFLECTOR) INSTALLATION REQUIRES KNOWLEDGE OF FLUORESCENT LIGHTING LUMINARIES ELECTRICAL SYSTEMS. IF NOT QUALIFIED, DO NOT ATTEMPT INSTALLATION. CONTACT A QUALIFIED ELECTRICIAN.
3. RISK OF FIRE OR ELECTRIC SHOCK. THE ELECTRICAL RATING OF THIS PRODUCT IS 120-277VAC., 50/60 HZ 10W/18W/22W. THE INSTALLER MUST DETERMINE WHETHER POWER SUPPLY IS 120-277VAC AT THE LUMINARIES BEFORE INSTALLATION.
4. RISK OF FIRE OR ELECTRIC SHOCK. LUMINARIES WIRING, BALLAST(S), OR OTHER ELECTRICAL PARTS MAY BE DAMAGED WHEN RETROFITTING. CHECK FOR ENCLOSED WIRING AND COMPONENTS.
5. RISK OF FIRE OR ELECTRIC SHOCK. DO NOT USE THIS RETROFIT KIT IN LUMINARIES EMPLOYING SHUNTED BI-PIN LAMP HOLDERS.
6. RETROFIT LUMINAIRE HAS BEEN MODIFIED AND CAN NO LONGER OPERATE THE ORIGINAL INTENDED LAMP(S).

WIRE CONNECTION

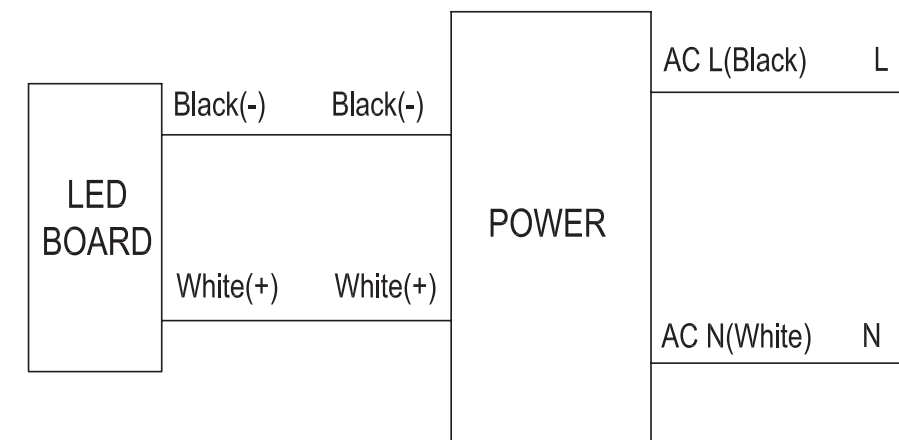

INSTALLATION

BY PASS MODE

WIRING INSTRUCTIONS-ELECTRONIC BALLAST

RETROFIT LUMINAIRE WITH 1 LAMP

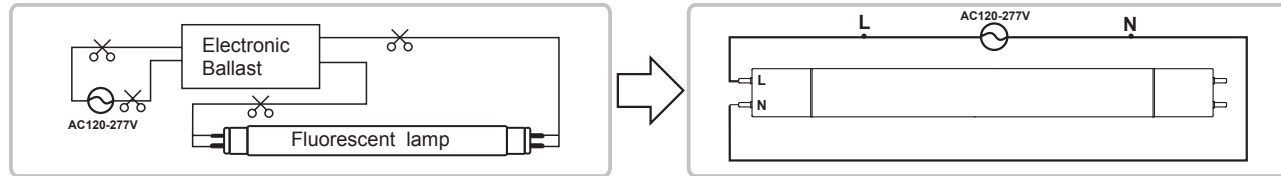

RETROFIT LUMINAIRE WITH 2 LAMP

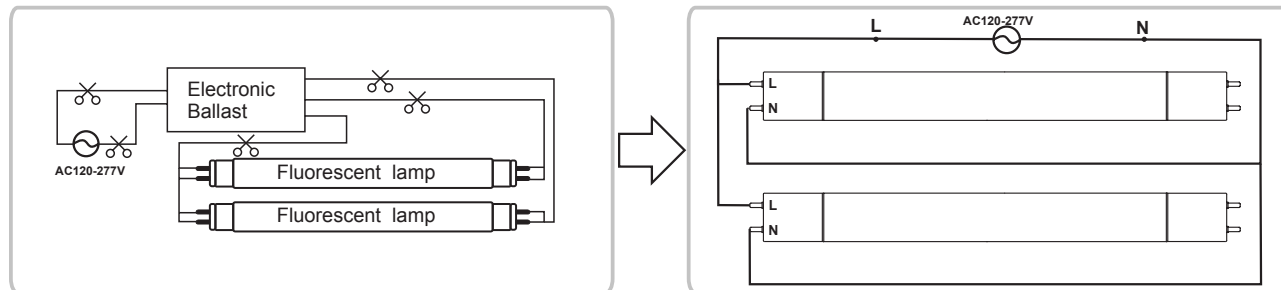

RETROFIT LUMINAIRE WITH 4 LAMP

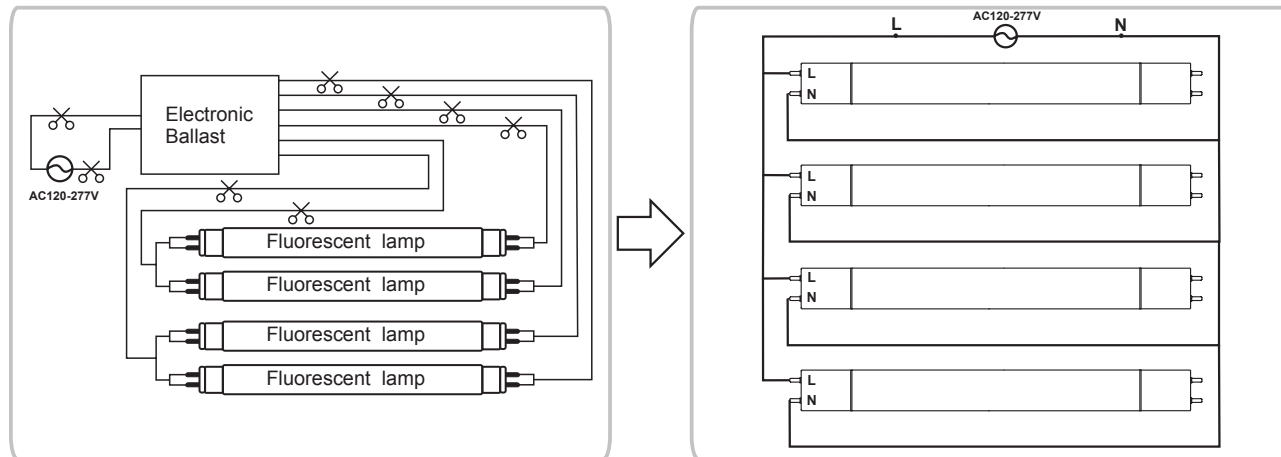

WIRING INSTRUCTION-MAGNETIC BALLAST

RETROFIT LUMINAIRE MAGNETIC BALLAST

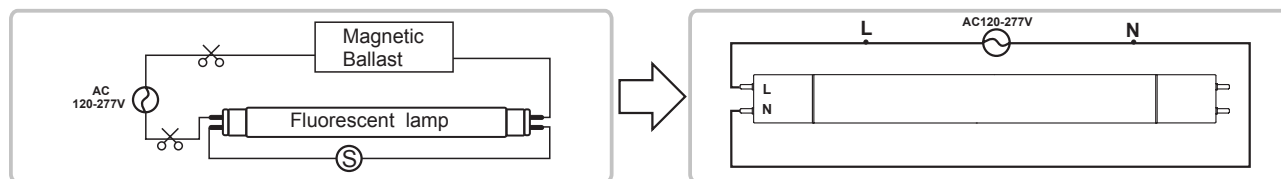

CAUTIONS:

- 1). Make sure the socket is un-shunted for L,N input terminal. (As shown in right)
- 2). The terminal with label shown below indicates that this terminal should be connected with mains.

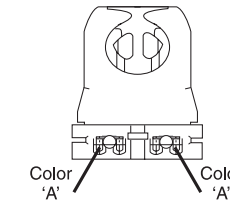
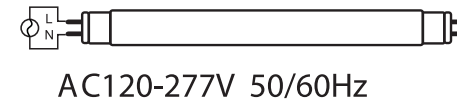

WARRANTY

LIMITED FIVE-YEAR WARRANTY. Should this product fail to perform satisfactorily due to a defect or poor workmanship within five years from the date of purchase, return it to the place of purchase and it will be replaced, free of charge. Incidental or consequential damages are excluded from the warranty.